

**9917027**

18W LED /  $\alpha=120^\circ$   
incl. LED Board: L9001972  
230V ~ 50Hz

**(DE) Bestimmungsgemäße Verwendung**

(GB) Intended use / (FR) Utilisation conforme / (NL) Beoogd gebruik / (PL) Stosowanie zgodnie z przeznaczeniem /  
(NO) Riktig bruk / (DK) Korrekt brug / (SE) Avsedd användning / (FI) Määräystenmukainen käyttö  
(IT) Impiego appropriato / (ES) Uso prescrito / (CZ) Použití v souladu s určením / (PT) Utilização correta / (GR) Ενδειγμένη χρήση

<b>(DE)</b>	Ortsfeste Verwendung als Deckeneinbauleuchte im Innenbereich	<b>(GB)</b>	Stationary use as recessed ceiling light, indoors
<b>(FR)</b>	Installation fixe en tant qu'plafonnier encastré, à l'intérieur	<b>(NL)</b>	Vast gebruik als Inbouwspot binnenshuis
<b>(PL)</b>	Do montażu stacjonarnego jako lampa sufitowa wpuszczana do wnętrza	<b>(NO)</b>	Til stasjonært bruk som innfelt taklampe innendørs
<b>(DK)</b>	Til stationær brug som loftindbygningslampe indendørs	<b>(SE)</b>	Används som fast takinbyggnadslampa inomhus
<b>(FI)</b>	Kiinteä käyttö sisätilojen kattouppovalaisimena	<b>(IT)</b>	Impiego fisso come plafoniera da incasso in ambienti interni
<b>(ES)</b>	Empleo fijo en tanto lámpara empotrable en el techo en interiores	<b>(CZ)</b>	Stacionární použití jako stropní zabudované svítidlo v interiéru
<b>(PT)</b>	Aplicação fixa como luminária de teto de montagem encastrada em interiores	<b>(GR)</b>	Σταθερή χρήση ως χωνευτό φωτιστικό οροφής σε εσωτερικό χώρο

**(DE) Verwendete Symbole**

(GB) Safety Precautions / (FR) Symboles utilisés / (NL) Gebruikte symbolen / (PL) Stosowane symbole / (NO) Brukte symboler /  
(DK) Brugte symboler / (SE) Använda symboler / (FI) Käytetyt symbolit / (IT) Simboli usati / (ES) Símbolos empleados /  
(CZ) Použité symboly / (PT) Símbolos utilizados / (GR) Χρησιμοποιούμενα σύμβολα

IP 44

**(DE) Lieferumfang**

(GB) Package contents / (FR) Contenu de la livraison / (NL) Bij de levering inbegrepen / (PL) Zakres dostawy / (NO) Levering /  
(DK) Leveringsomfang / (SE) Leveransomfattning / (FI) Toimitussisältö / (IT) Fornitura / (ES) Volumen de suministro /  
(CZ) Rozsah dodávky / (PT) Material fornecido / (GR) Παραδοτέος εξοπλισμός

<b>(DE)</b>	1 Deckeneinbauleuchte Montagematerial Montageanleitung	<b>(GB)</b>	1 Recessed spotlights Installation hardware Mounting instructions	<b>(FR)</b>	1 Spot encastré Matériel de montage Instructions de montage
<b>(NL)</b>	1 Inbouwspot Monteringsmateriale Montagehandleiding	<b>(PL)</b>	1 Reflektor wpuszczany Elementy montażowe Instrukcja montażu	<b>(NO)</b>	1 Innfelt taklampe Monteringsmateriale Brukerveiledning
<b>(DK)</b>	1 Loftindbygningslampe Monteringsmateriale Brugervejledning	<b>(SE)</b>	1 Takinbyggnadslampa Monteringsmaterial Monteringsanvisning	<b>(FI)</b>	1 Kattouppovalaisin Asennusmateriaali Asennusohjeet
<b>(IT)</b>	1 Plafoniera da incasso Materiale di montaggio Istruzioni di montaggio	<b>(ES)</b>	1 Lámpara empotrable en el techo Material de montaje Instrucciones de montaje	<b>(CZ)</b>	1 Stropní zabudované svítidlo Materiál pro montáž Návod k montáži
<b>(PT)</b>	1 Luminária de teto de montagem encastrada Material de montagem Instruções de montagem	<b>(GR)</b>	1 Χωνευτό φωτιστικό οροφής Υλικό συναρμολόγησης Οδηγίες συναρμολόγησης		

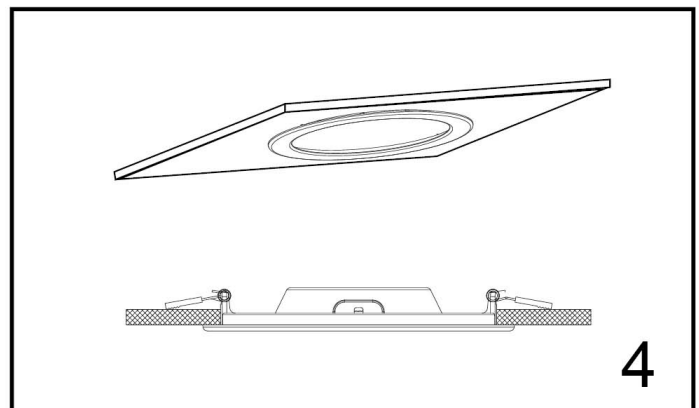
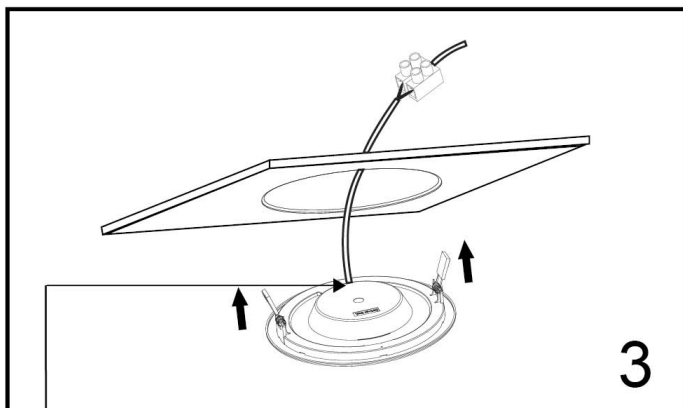
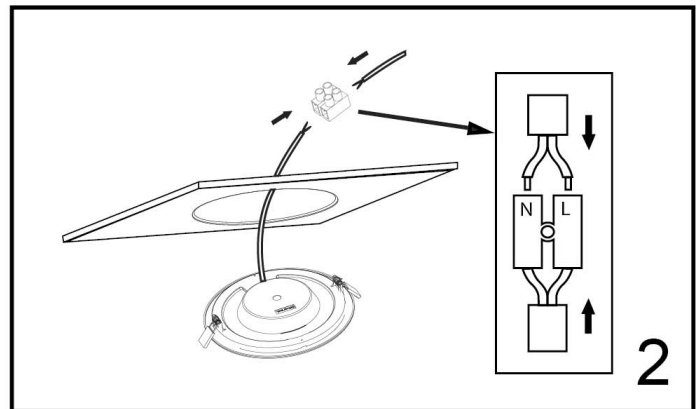
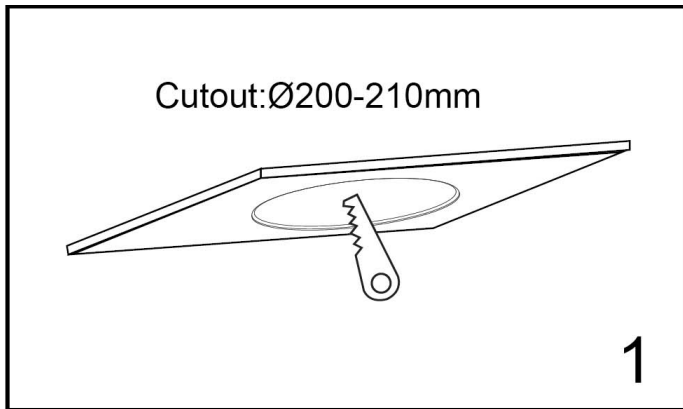
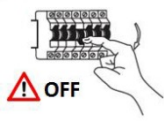

DIP Schalter zur Auswahl der Farbtemperatur  
Colorchange via dip switch  
Changement de couleur via commutateur DIP

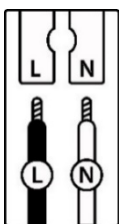
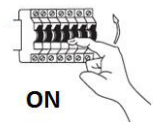
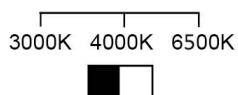

	(DE)	(GB)	(FR)	(NL)	(PL)	(NO)	(DK)
<b>L</b>	Stromführender Leiter	Live conductor	Conducteur	Spanningvoerende draad	Przewód prądowy	Strømførende leder	Strømførende leder
<b>N</b>	Neutralleiter	Neutral conductor	Conducteur neutre	Nulleider	Przewód zerowy	Nøytralleider	Neutralleider

	(SE)	(FI)	(IT)	(ES)	(CZ)	(PT)	(GR)
<b>L</b>	Strömförande ledare	Virtajohdin	Conduttore sotto tensione	Líneas conductoras de corriente	Vodič pod napětím	Condutor vivo	Ρευματοφόρος αγωγός
<b>N</b>	Neutralledare	Nollajohdin	Conduttore neutro	Conductor neutro	Neutrální vodič	Condutor neutro	Ουδέτερος αγωγός

	QR	EAN
<p>(DE) Dieses Produkt enthält eine Lichtquelle der Energieeffizienzklasse F            (EN) This product contains a light source of energy efficiency class F            (FR) Ce produit comprend une source de lumière de classe d'efficacité énergétique F            (NL) Dit product bevat een lichtbron van energie-efficiëntieklasse F            (PL) Produkt ten zawiera źródło światła o klasie efektywności energetycznej F            (NO) Dette produktet inneholder en lyskilde i energieeffektivitetsklasse F            (DK) Dette produkt indeholder en lyskilde af energieeffektklasse F            (SE) Denna produkt innehåller en ljuskälla i energieffektivitetsklass F            (FI) Tämä tuote sisältää energiatehokkuusluokan F valonlähteen            (IT) Questo prodotto contiene una sorgente luminosa della classe di efficienza energetica F            (ES) Este producto contiene una fuente de luz de la clase de eficiencia energética F            (CZ) Tento výrobek obsahuje světelný zdroj třídy energetické účinnosti F            (PT) Este produto contém uma fonte de luz da classe de eficiência energética F            (GR) Αυτό το προϊόν περιέχει μια φωτεινή πηγή ενεργειακής απόδοσης κλάσης F            (SK) Tento výrobok obsahuje zdroj svetla triedy energetickej efektivity F</p>		<p>4251911737752</p>

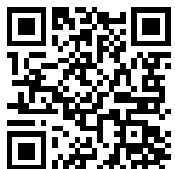
	<p>(DE) Durch einen Fachmann austauschbare Lichtquelle (nur LED)            (EN) Replaceable (LED only) light source by a professional.            (FR) Source de lumière remplaçable (LED uniquement) par un professionnel.            (NL) Lichtbron (alleen led) te vervangen door een professional.            (PL) Wymienne (tylko LED) źródło światła wykonane przez profesjonalistę.            (NO) Utskiftbar (kun LED) lyskilde av en profesjonell.            (DK) Udskiftelig lyskilde (kun LED), udskiftes af en elektriker.            (SE) Ljuskälla (endast LED) utbytbar genom fackman.            (FI) Ammattilainen voi vaihtaa vaihdettavan (vain LED) valonlähteen.            (IT) Sorgente luminosa (solo LED) sostituibile da un professionista.            (ES) Fuente de luz (solo LED) sustituible por un profesional.            (CZ) Vyměnitelný (pouze LED) světelný zdroj odborníkem.            (PT) Luz LED (apenas LED) substituível por um profissional.            (GR) Η πηγή φωτός (μόνο LED) να αντικαθίσταται από επαγγελματία.            (SK) Zdroj svetla (iba LED) vymeniteľný prostredníctvom odborníka.</p>
--	---

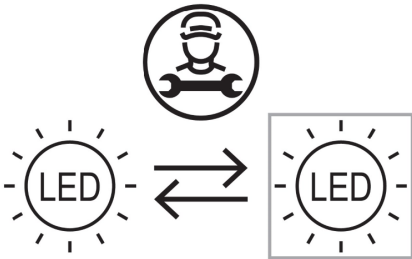
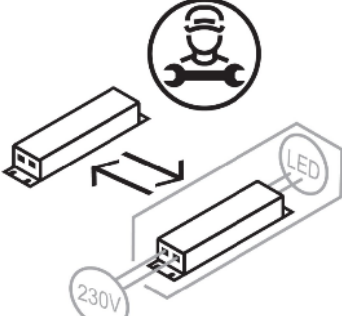
	<p>(DE) Durch einen Fachmann austauschbares Betriebsgerät.            (EN) Replaceable control gear by a professional.            (FR) Contrôleur remplaçable par un professionnel.            (NL) Voorschakelapparatuur te vervangen door een professional.            (PL) Wymienny układ sterujący przez profesjonalistę.            (NO) Utskiftbar kontrollutstyr av en profesjonell.            (DK) Udskiftelig igangsætter, udskiftes af en elektriker.            (SE) Styrdon utbytbar genom fackman.            (FI) Ammattilainen voi vaihtaa vaihdettavat ohjauslaitteet.            (IT) Dispositivo di controllo sostituibile da un professionista.            (ES) Dispositivo de control sustituible por un profesional.            (CZ) Vyměnitelný předřadník odborníkem.            (PT) Dispositivo de controlo substituível por um profissional.            (GR) Ο εξοπλισμός ελέγχου να αντικαθίσταται από επαγγελματία.            (SK) Predradník vymeniteľný prostredníctvom odborníka.</p>
---	--